

Ceiling LED Pendant

PD76316
INSTALLATION SHEET

START FROM HERE

- Make sure **POWER** is **COMPLETELY OFF** at the fuse box
- Have your fixture installed by a qualified licensed electrician
- Prepare everything in a clear area
- Wear gloves at all time during this installation
- Read instructions carefully before you start assembly
- Keep this installation sheet for future reference

Technical Support: 1-855-855-8926

Please Note:

- This Kuzco LED fixture comes with pre-wired LED module(s)
- Unless instructed, Do Not touch any part of the LED module(s) as any unnecessary contact with the module could cause permanent damage
- Use ELV (Electronic Low Voltage) or TRIAC type of dimmer for dimming application
- 120V input

- 1.** Remove fixture from its original package
- 2.** Separate mounting plate (**1c**) from canopy (**2a**) by removing canopy screws (**2b**)
- 3.** Attach mounting plate (**1c**) to electrical junction box (**1a**) using junction box screws provided (**1e**) in hardware package
- 4.** To change fixture height, push and hold wire gripper (**2g**), slide wire to desired length and then release wire gripper (**2g**) to secure
- 5.** Make proper electrical connections (**black to hot "L"**, **white to neutral "N"**, **ground to "GND"**) with wire nuts (**1b**) provided in hardware package and place driver (**4a**) inside canopy (**2a**)
- 6.** Secure top diffuser (**3b**) and bottom diffuser (**3e**) to fixture frame (**3d**) by threading clockwise, followed by top glass (**3a**) and bottom glass (**3f**) and secure with screws (**3c**)
- 7.** Attach canopy (**2a**) to mounting plate (**1c**) with canopy screws (**2b**)
- 8.** Fine tune wire length if necessary, by push and hold wire gripper (**2g**) and then adjust wire to desired length

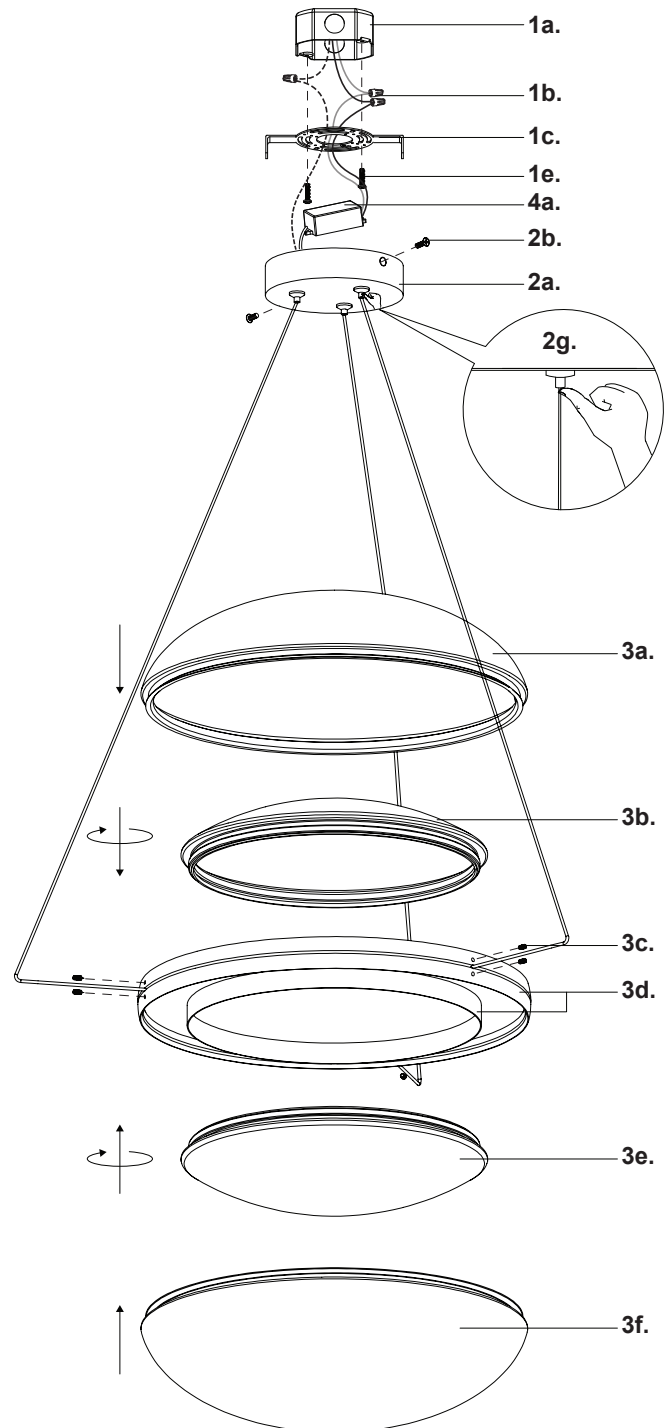

KUZCO

19054 28th Avenue Surrey, BC Canada V3Z 6M3
T: 604 538 7162 TF: 1-855 85 KUZCO F: 604 538 7196
W: kuzcolighting.com
20241113